

Please Approve this Drawing

Date

Signature

NO.	Part Name	Q'TY	Material	Plated surface
1	Pin	4	无铅铜	Au 5u" Min. OVER 50U~120" Ni
2	Magnet	2	耐高温150度	Ni Plating
3	Housing	1	High temp.Plastic; UL94 V-0 Color Black	
4				

NOTES:

- Electrical
 - .Rated Current & Voltage : DC 12 V ; 3.0A Max.
 - .Contact Resistance: 50 mohm maximum at Working Height(Quiescence)
- Environmental
 - .Operating Temperature: -40°C~+85°C
 - .Humidity Range: 10%RH~90%RH
 - .Salt Spray: 48 Hours
 - .Dustproof and waterproof: IP66
- .RoHS&HF compliant product.

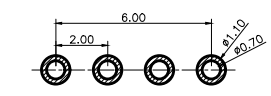
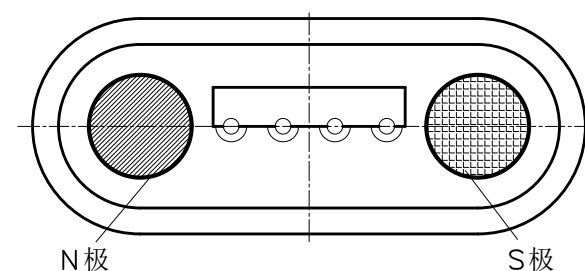
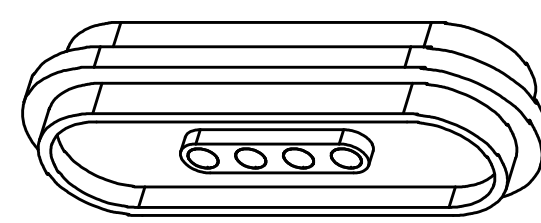
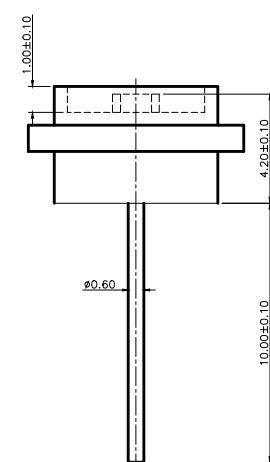
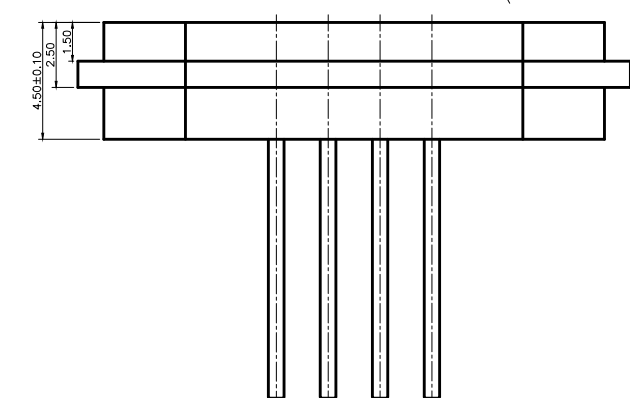
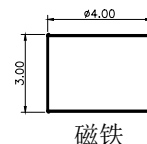
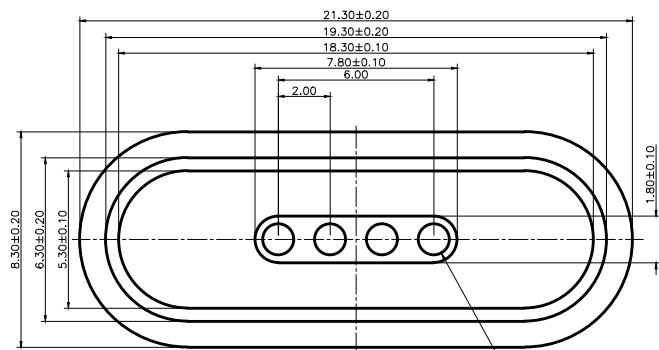

Recommended pcb layout
Layout tolerance: ±0.05mm

VER.	DESCRIPTION	ECN NO.	DATE

DRAWN	Lys	DATE	2022.12.12		Dongguan Promax Electronics Technology Co., Ltd.
CHECKED		SCALE	10:1	VER. A.0	
APPROVED		TITLE	Pin		Ang:
PROJECT		DRAWING NO.	NF5498-04PA		0 ±1°
SHEET	1 of 1	UNIT	mm		.0 ±0.5°
					.00 ±0.25°
					Dim:
					0 ±0.15
					.0 ±0.10
					.00 ±0.05