

Please Approve this Drawing

Date

Signature

NO.	Part Name	Q'TY	Material	Plated surface
1	Pin	4	HBI59	AU 15 U" MIN OVER 50~100 U" NI
2	Housing	1	PA9T	UL 94V-0, Black
3	Magnet	1	N52	200u" Ni MIN.

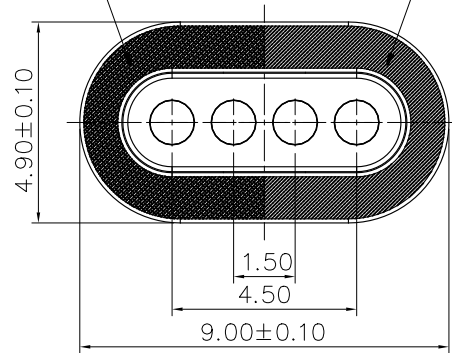

SOUTH POLE NORTH POLE

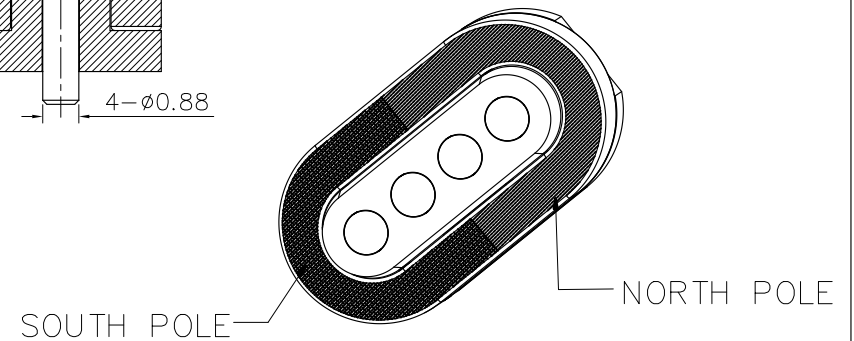
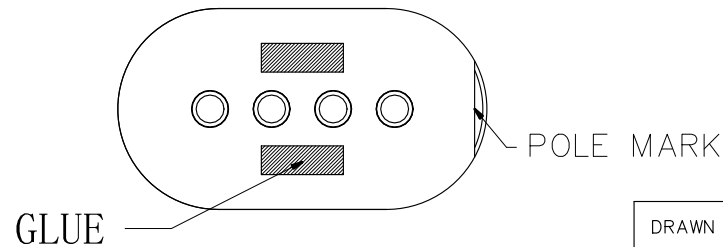
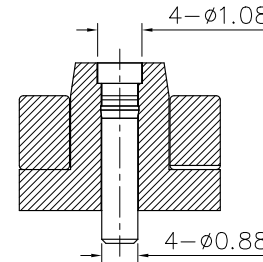
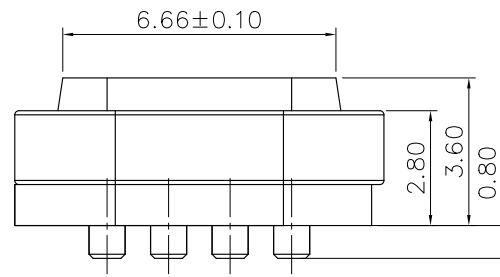
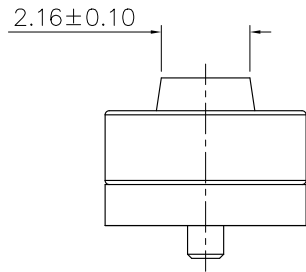

NOTES:

- Electrical
  - .Rated Current & Voltage : DC 12 V ; 1 A
  - .Contact Resistance: 50 mohm maximum at Working Height(Quiescence)
- Environmental
  - .Operating Temperature: -25°C~+85°C
  - .Humidity Range: 10%RH~90%RH
  - .Salt Spray: 48 Hours
- .RoHS&HF compliant product.



DRAWN	Eddie	DATE	2023.05.19		 Dongguan Promax Electronics Technology Co.,Ltd
CHECKED		SCALE	10:1	VER. A.0	
APPROVED		TITLE	Magnet&pogo connector.		Ang:
PROJECT		DRAWING NO.	NF6006-04PA		0 ±1°
SHEET	1 of 1	UNIT	mm		.0 ±0.5°
					.00 ±0.25°
					Dim: 0 ±0.15
					.0 ±0.10
					.00 ±0.05

VER.	DESCRIPTION	ECN NO.	DATE